

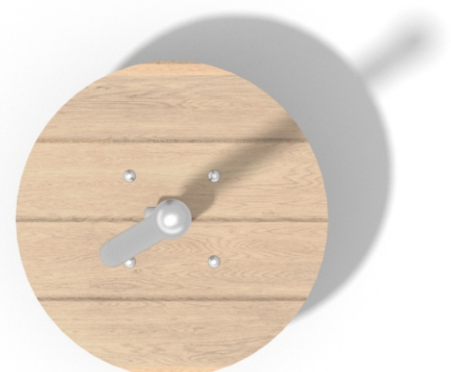
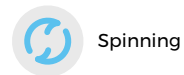

Information about the product

Dimensions	46 x 46 cm
Safety zone	346 x 346 cm
Safety zone area	9,40 m ²
Overall height	117 cm
Free fall height	32 cm
Amount of users	1
Highest element	217 cm
Heaviest element	30 kg
Product complies with EN 1176-1:2017-12	Yes
Availability of spare parts	Yes
Age range	1 -12

According to EN 1176-1:2017-12 norm, the product requires applying a safety surface according to the product's free fall height.

Functions

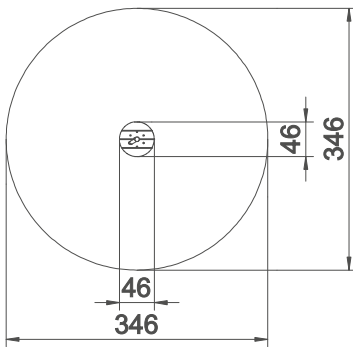
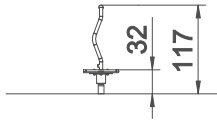
1:100



Due to the height of the free fall of the product, the EN 1176-1:2017-12 norm allows following types of fall- absorbing surfaces:

Impact surfaces around carousels should provide an adequate level of shock absorption, corresponding at least to the free fall height, but always no less than 600 mm.

Material	Description	Minimal layer thickness mm
Top layer of the soil		
Turf		
Bark	Chipped bark of coniferous trees (no wood-based materials), the size of the pieces between 20mm to 80mm	200
Wood chips	Mechanically fragmented wood without bark and leaves, size of the pieces between 5 mm to 30	200
Sand or gravel	Particle size between 0,25 mm to 8 mm	200
Synthetic material	Synthetic material with an approval for free fall heights ≥ 70 cm	

All types of surfaces need to be preserved by adding bulk material and removing extraneous matters. Broken glass is considered to be most hazardous.

Installation method

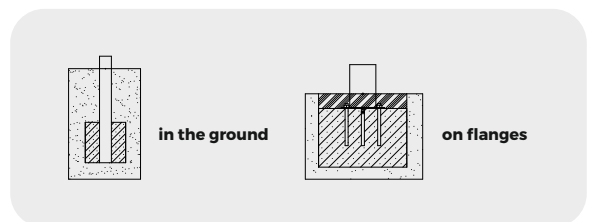

Warranty



The Guaranty covers all flaws of the elements made of HPL, HDPE, stainless steel, hot-dip galvanized steel, wooden elements (pine, spruce), revealed during usage, which arise from manufacturing reasons.



The Guaranty covers all flaws of the elements made of powder coated steel, aluminum, laminate, ropes, elements made in rotomoulding technology, elements made of polyamid, polypropylene elements, revealed during usage, which arise from manufacturing reasons.



The Guaranty covers all flaws of the elements made of rubber, moving elements (bearings, joints), electronic elements, elements made of EPDM, elements made of plywood and other not mentioned before revealed during usage, which arise from manufacturing reasons.

Product description

Structure: The carousel shaft and platform plate are made of black steel, cleaned through shot blasting and protected against corrosion by powder galvanising and powder coating.

Platform: Made from 25mm thick boards of robinia wood.

Central pole: Made of a stainless steel tube with a diameter of 42.4mm, cleaned in the process of bead blasting.

Materials

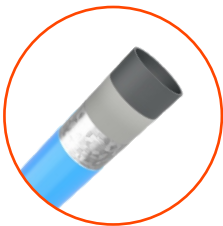

Solid construction elements made of black steel cleaned in the sandblasting process. odporými na UV.



Natural robinia wood.

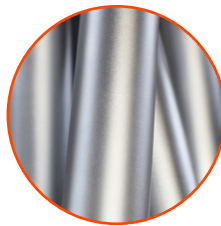

Elements made of stainless steel AISI304 totally resistant to various weather conditions.