

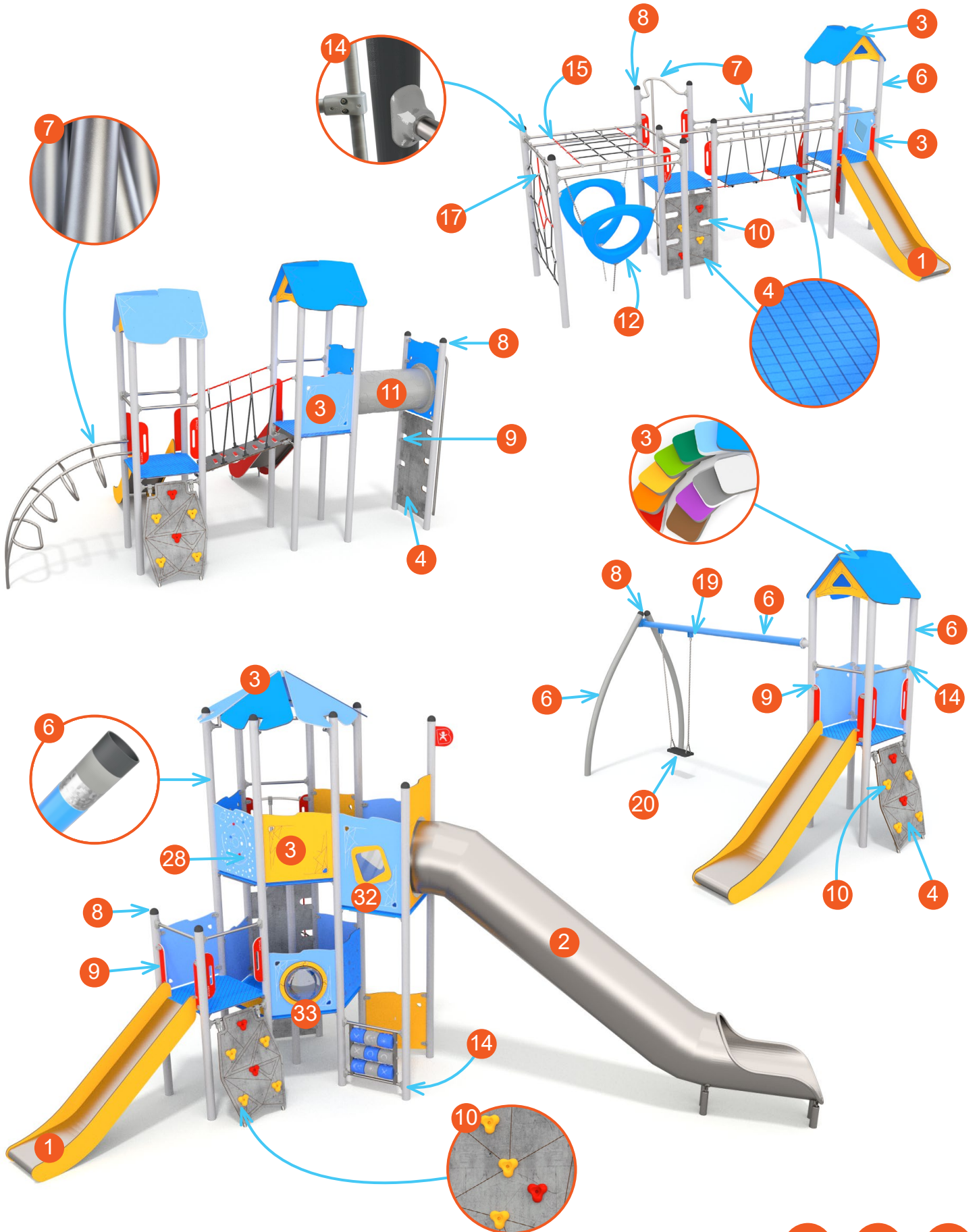

# Buglo

## Active MATERIAL SPECIFICATION



Let's play





# Buglo

## Active MATERIAL SPECIFICATION

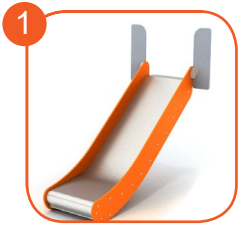

Slides made of stainless steel AISI 304. Metal sheet with a thickness of 2 mm formed in a CNC technique. Side panels made of HDPE polyethylene 15 mm, in the highest quality and totally damp-proof and resistant to UV.



Tube slide made of stainless steel AISI 304. The metal sheet is 2 mm thick and the end section is finished with a band made of pipe 33,7 mm. The surface is polished.



Plates of the walls made of colourful triple layered 15 mm HDPE polyethylene, in the highest quality, totally damp-proof and resistant to UV.



Plates of the walls and platforms made of colourful 13 mm HPL (black plates made of 8 mm HPL), in the highest quality, totally damp-proof and resistant to UV.



Anti-slip anthracite 10 mm HPL platform plate with a very high resistance to weather conditions and attrition.



Solid construction made of black steel S235JR, cleaned in the sandblasting process. Protected against corrosion by galvanizing and powder coating with polyester paint QUALICOAT attested.



Solid construction made of stainless steel AISI 304 totally resistant to weather conditions. Solid construction made of stainless steel AISI 304 totally resistant to weather conditions.



Post endings finished with soft EPDM rubber.



Plate and rope connectors made of injection molded polyamide.



Climbing rocks made of chippings and colourful polyester resin.



Tube made of LDPE polyethylene rotationally molded with the inner diameter of 53,3 cm and the length of 125 cm.



Ergonomically-shaped polyethylene rings improving the physical well-being and motor coordination.



Connecting elements like screws, nuts, washers made of stainless steel. Vandal-proof screw plugs made of injection molded polyamide.



System of connectors and clamps made of strong aluminum alloy. Aluminum is secured by the process of electrophoresis and powder coating with polyester paint UV resistant and QUALICOAT attested.



Polypropylene ropes pp-multisplit type with a steel core and a diameter of 16 mm.

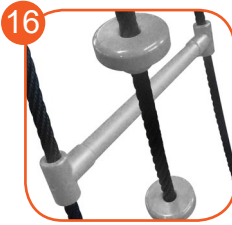

Rope ladder steps and rope knots made of injection molded polyamide.

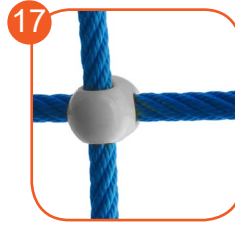

Solid and esthetic rope connectors made of injection molded polyamide.

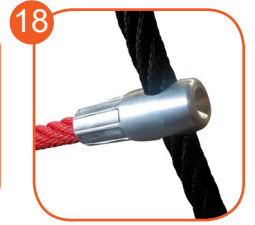

Rope endings pressed in a sleeve made of durable aluminum alloy.



Swing slings, with double bearings, made of stainless steel guarantees a quiet mechanism operation. Beside the horizontal movement it also allows the circular movement to avoid a chain twisting.



The seats are made of aluminum construction covered with a soft EPDM rubber, hanged on 6mm stainless steel chains.



Flexible seat made of reinforced belt covered with soft rubber, hanged on 6 mm stainless steel chains.

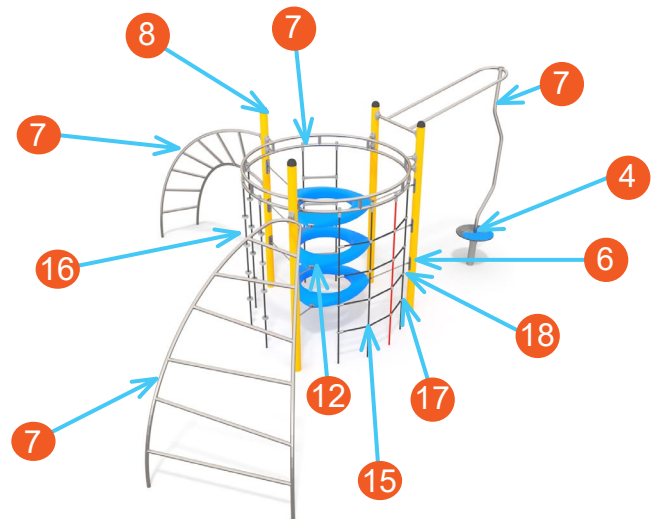



Milled educational board made of 15mm HDPE plate. Stimulates children senses.



Milled educational board, made of 15mm HDPE plate. Allows to learn basic English words.



Milled educational board made of 15mm HDPE plate. Allows to learn basics of sign language.



Milled educational board made of 15mm HDPE plate. Allows to learn basics of Braille's alphabet



Milled educational board made of 15mm HDPE plate. Allows to learn basics of math.



Milled educational board made of 15mm HDPE plate. Stimulates children senses.



Milled educational board made of 15mm HDPE plate with moving parts made of injection molded polyamide.



Rotary module, made of 13mm HPL plates. Stimulates the senses and supports the development of child's motor skills.



Rotary module, which allows to move the ball in the maze, made of HDPE plate, safe polycarbonate and stainless steel.



Rotary module made of 13mm HPL plates. Stimulates children senses and supports development of their motor skills.

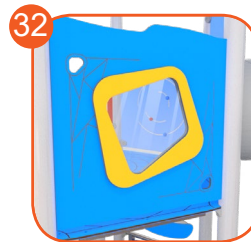

The windows are made of safe polycarbonate 8 mm thick.



Hemispheric window with a diameter of 400 mm. Material: heat - formed polycarbonate 5 mm thick.